

## TERMS & CONDITIONS

1. The maps data and/or preloaded software ("Software") in this device are licensed by third parties to Amtel Cellular Sdn Bhd ("The Company"). The Software is sub-licensed on a limited, non-exclusive, non-transferable and revocable basis for use by you solely on this device only and is not sold together with the device. If upgrades, updates or supplements to the Software are obtained, the use of such upgrades, updates or supplements is governed by these Terms and Conditions and any amendments that may accompany them and may be subject to additional payments and conditions. You must not reproduce, distribute, publish, transmit, modify, adapt, translate, display, distribute, sell, license, publicly perform, prepare derivative works based upon, or otherwise use or exploit the Software. The foregoing limited right does not give you any ownership of Software and nothing contained in this Agreement may be construed as conferring to you any licence or right to the Software under any copyright or any other intellectual property right.
2. The Software is provided by the copyright holders "AS IS" and any express or implied warranties, including, but not limited to, the implied warranties of merchantability and fitness for a particular purpose, are disclaimed. In no event shall the copyright owner be liable for any direct, indirect, incidental, special, exemplary, or consequential damages however caused and on any theory of liability, whether in contract, strict liability, or tort (including negligence or otherwise) arising in any way out of the use of the Software, even if advised of the possibility of such damage. The entire risk to the quality and performance of the Software is borne by you. This disclaimer of warranty constitutes an essential part of the licence granted to you to use the Software.
3. The trademarks, logos, and service marks ("Trademark") displayed on this Software and device, are owned by the Company and third parties. All Trademarks not owned by the Company are the property of their respective owners, and are used with permission. Nothing contained herein may be construed as granting any right or licence to use any Trademark.
4. The maps and any information stored in this device is strictly a navigation guide for reference use only. It is the sole responsibility of the User's to use this device prudently. Information provided may change over time and you should decide the route based on the actual road conditions and traffic laws. The Company makes no representation or warranty, whether expressly or impliedly as to the accuracy, completeness, timeliness, reliability or fitness for any particular purpose of the maps stored therein.
5. The planned, shortest, quickest routes and estimated time to desired destinations are obtained from optimal route calculations based on the map database and should be used as a reference only. This device must not be used for any purpose requiring precise measurement of direction, distance, location or topography.
6. Do not fix or mount the device on such part of the windscreen that will interfere with driving of the motor vehicle or be hazardous or dangerous to the driver or occupants in the motor vehicle. User shall be responsible for his/her use of the maps stored therein and the device, and shall at all times comply with all traffic laws and regulations of the country of usage.
7. The usage of this device is dependent on the Global Positioning System (GPS) which is operated by the United States government and is solely responsible for its accuracy and maintenance. The system is subject to changes which may affect the performance and accuracy of the GPS navigator devices.
8. The use of the device is at the User's own risk. Lokatoo and the company is not liable for any fines, penalties, damages or loss whether direct, indirect, incidental, special, exemplary, or consequential damages however caused and on any theory of liability, whether in contract, strict liability, or tort (including negligence or otherwise) arising in any way out of the use of the device.



## HARDWARE USER MANUAL

### Lokatoo A1000 (HD)

Version 2.4

#### What is in the box?

01. Lokatoo A1000 (HD) GPS Navigator
02. Stylus
03. Pouch
04. Holder
05. Cradle
06. In-car charger
07. Travel adaptor
08. USB cable
09. CD containing map and manual
10. Quick guide
11. Software user manual
12. Hardware user manual
13. Warranty card

For the latest version of this manual, please visit  
[www.lokatoo.com](http://www.lokatoo.com)

#### Precautions and Notices

- For your own safety, do not operate the controls of the product while driving.
- When you get off the car, do not leave your device on the dashboard that is subject to direct sunlight. The overheating of the battery can cause malfunction and/or danger.
- Global Positioning System (GPS) is operated and managed by the United States of America Department of Defense, which is solely responsible for the performance of GPS. Any change or modification may affect the accuracy of the GPS and its related systems.
- GPS satellite signals cannot pass through solid materials (except glass). When you are inside a tunnel or building, GPS positioning is not available.
- A minimum of 3 GPS satellite signals is needed to determine current GPS position. Signal reception can be affected by situations such as bad weather or dense overhead obstacles (e.g. trees and tall buildings).
- Other wireless devices in the vehicle might interfere with the reception of satellite signals and cause the reception to be unstable.
- A car holder is needed when using the device in a car. Be sure to place the device in an appropriate place, so as not to obstruct the driver's view, or deployment of airbags.
- Please remove SD/MMC card only when the device is in power off status.
- When USB transmitting, **Do Not** disconnect the USB cable. When other applications are operating, **Do Not** connect USB cable.
- The navigation software may be updated from time to time. If the description shown in this manual is different, please follow the software version currently on hand.

#### Battery Information

For optimal performance of the Li-polymer battery, take note of the following:

- This unit contains a non user replaceable internal Li-polymer battery. The battery can inflate and release hazardous chemicals. To reduce the risk of fire or burns, do not disassemble, crush, puncture, or dispose of in fire or water.
- The icon  at the top right corner on the main interface of system indicates the current remaining power.
- Disconnect device from charger when it is fully charged. Battery may damage if it is over charged.
- Do not immediately turn on your device after connecting the Travel Adaptor to charge a power-depleted battery. If you need to turn on the device again, wait for at least one minute.
- Do not charge the battery where the temperature is high. This may be harmful to the battery. (e.g. in direct sunlight).
- It is unnecessary to fully discharge the battery before charging. You can charge the battery even if it is only partially discharge.
- If you do not use the device long period of time, charge the battery at least once every two weeks. Over discharge battery can affect the charging performance.
- **Only connect the In-Car Charger to the device after starting the car. Failure to do so may cause irreversible damage to the device.**

## Getting to know your Lokatoo A1000 (HD) GPS navigator

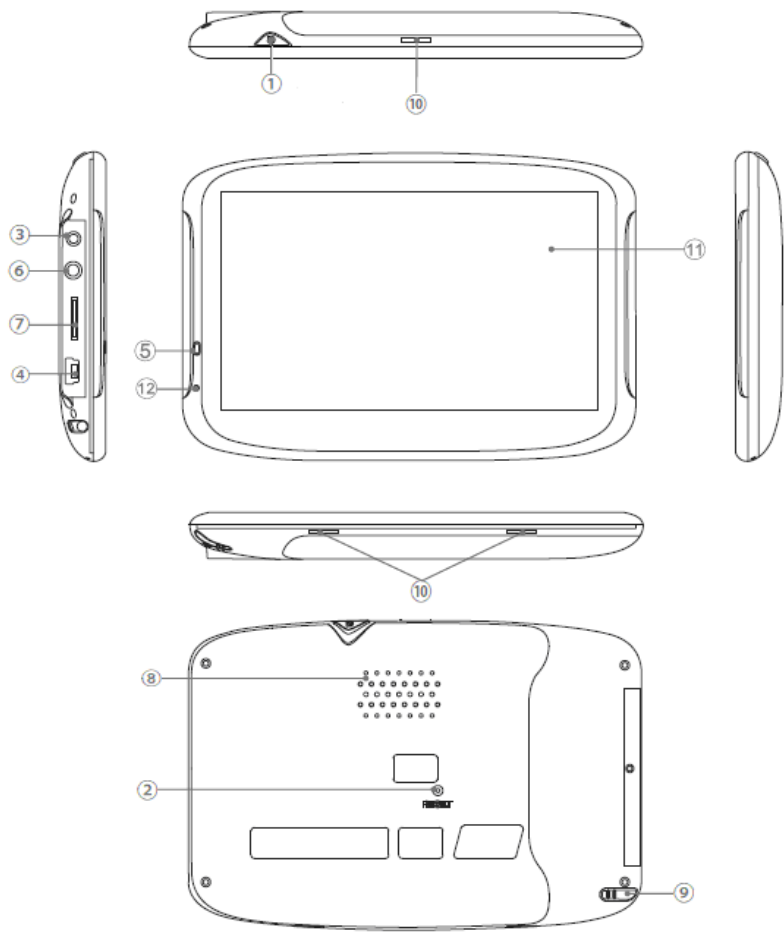

1	<b>Power button</b>	To turn on the device. To shut down or to put the device to sleep mode.
2	<b>Reset button</b>	To reset the device.
3	<b>AVIN Connector</b>	Connect to external AVIN wired receiver module. (Optional)
4	<b>Mini-USB Connector</b>	Connect to the USB cable for file transfer or battery charging.
5	<b>Charging Indicator</b>	Red – Charging Green – Fully charged
6	<b>Headphone Connector</b>	Connect to stereo headphone.
7	<b>SD/MMC Card slot</b>	To access song and video files stored in SD/MMC card.
8	<b>Speaker</b>	Audio output
9	<b>Stylus</b>	For inputting via touch screen.
10	<b>Bracket block slot</b>	To lock the device to holder.
11	<b>Display screen</b>	Display screen with touch screen capability.
12	<b>Microphone</b>	For inputting via voice. (Dependent on software capability)

## Mounting The Device To Holder

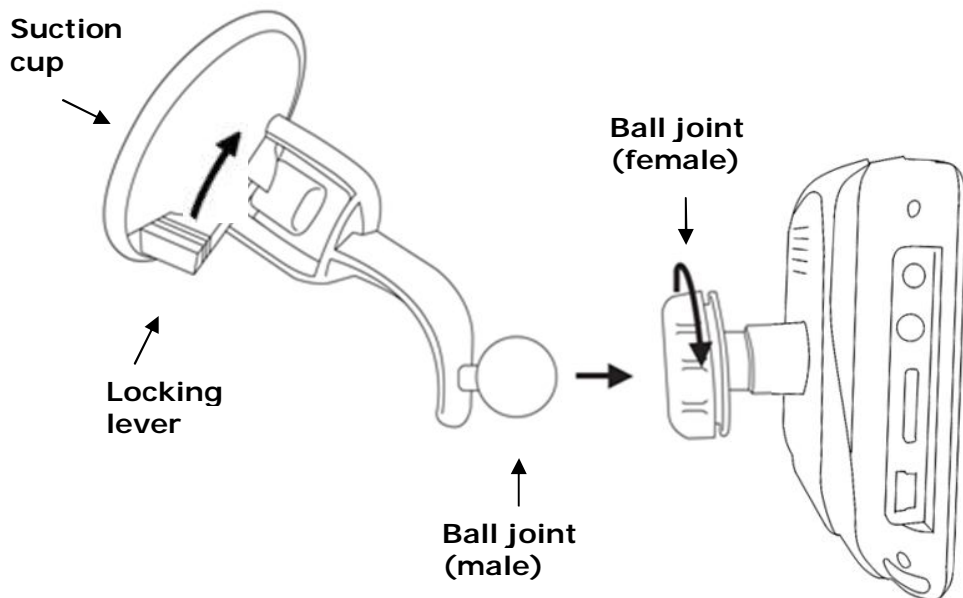

1. Turn the tightening knob anticlockwise to loosen the ball joint (female). Insert the ball joint (male) as shown on the illustration above, and then tighten the knob.
2. Attach the suction cup to the windscreen. Turn the locking lever clockwise to secure the mounting.
3. Fit the navigator to the holder.

### Important

Be sure to place the device in an appropriate place, so as not to obstruct the driver's view, or deployment of airbags.

## Main Interface Menu

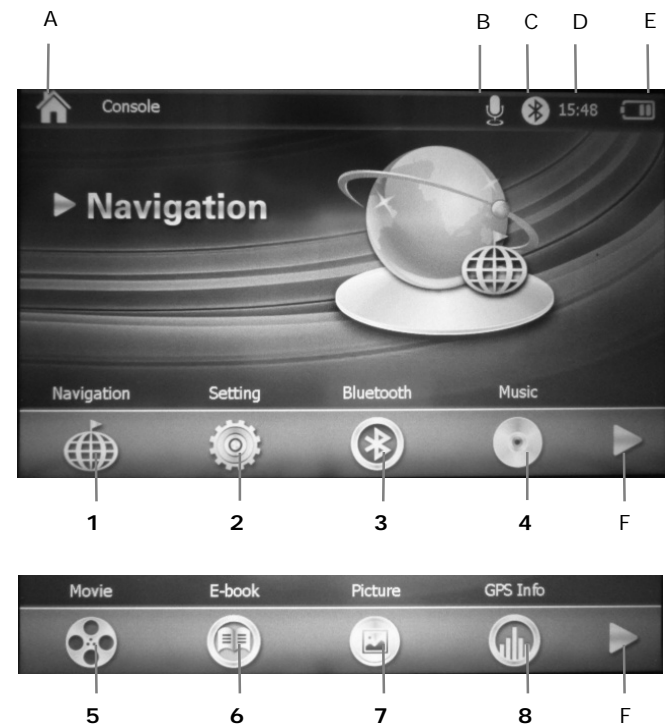

A	<b>Home</b>	Press to go to main menu screen.
B	<b>Volume</b>	Press this icon to enter the Volume setting page.
C	<b>Bluetooth</b>	Press this icon to enter Bluetooth setting page.
D	<b>Time</b>	Display the current time.
E	<b>Battery Indicator</b>	Display the battery level of the device.
F	<b>Next Page</b>	Press to go to next page.

## 1. Navigation

Tap this icon to launch the navigation software. (Please refer to the navigation software user manual)

## 2. Setting

Tap Setting icon from main menu to enter the setting page. Here you can set the time zone, language, brightness, power, volume, time and date. You can also view system information, and perform touch screen calibration here.

### 2.1. Zone



- |                         |                    |
|-------------------------|--------------------|
| A. Return to Main menu. | C. Next            |
| B. Previous             | D. Close and exit. |

### 2.2. Preferences



- |   |  |
|---|--|
| A. Return to Main menu.   | D. To set the duration before the system is put to sleep mode. |
| B. To select language.  | E. To adjust the volume.                                       |
| C. To set screen brightness and the duration before the screen is turned off. | F. Close and exit.   |

### 2.3. Date & Time

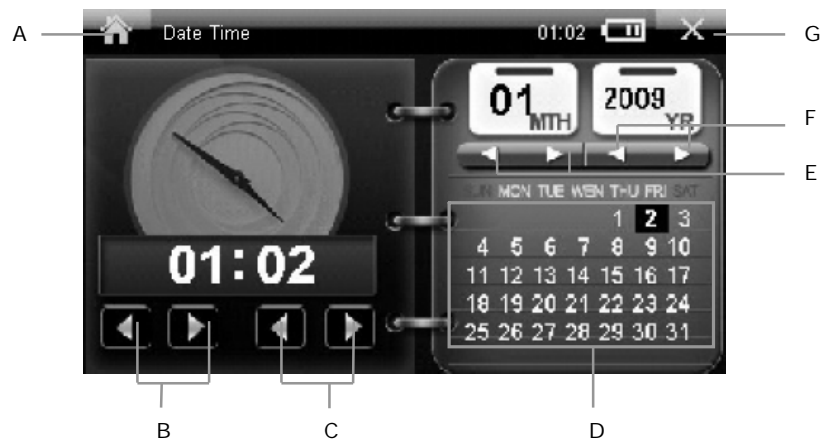

- A. Return to Main menu
- B. To set the hour
- C. To set the minute
- D. To select the day of the month
- E. To set the month
- F. To set the year
- G. Close and exit

Note: You do not need to adjust the date and time. When the device is connected to GPS satellite, the current date and time will be downloaded to the device.

### 2.4. Calibration

Please perform screen calibration to correct the preciseness of the touch screen. Press and briefly hold a stylus or any similar non-marking instrument to the center of the target. Repeat as the target moves around the screen. When the calibration is completed, simply tap anywhere on the screen to exit.

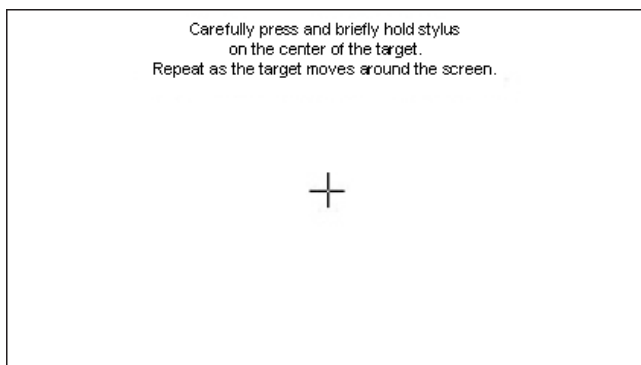

### 3. Bluetooth

The Bluetooth function allows the navigator to be paired to a mobile phone for making and answering calls.



Before Bluetooth can be used, both devices need to be matched (Paired). Press **Pairing** from the Bluetooth menu screen to enter into the equipment pairing interface, then, search for Bluetooth equipment (navigator) via your mobile phone. Once the Bluetooth equipment (navigator) is found, enter the pairing password (Default: 8888). You can change the password in the Bluetooth **Settings** page. Once the pairing is successful, establish a connection from your mobile phone. Otherwise, repeat the pairing steps.

**Note**  
Bluetooth option in mobile phone must be activated in order to pair successfully.

<b>Key Pad</b>	To access the key pad for making call.
<b>Contacts</b>	To access the phone book.
<b>Recent Calls</b>	List down calls made, calls rejected and calls received.
<b>Settings</b>	To set the pairing password and auto answer option.
<b>Pairing Record</b>	Display the list of mobile phone that paired with the navigator previously. You can connect, disconnect or remove the mobile phone profile from the list.
<b>Pairing</b>	Press to activate the Bluetooth function. Then, use your mobile phone to search the navigator's Bluetooth profile.

### 4. Music

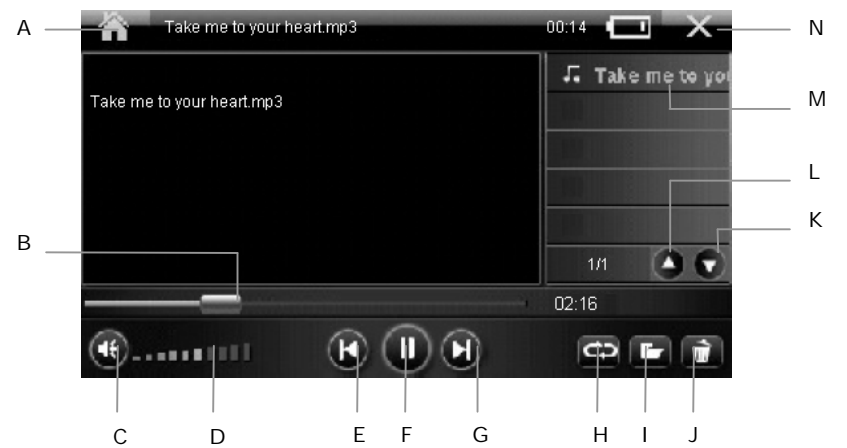

- A. Return to Main menu
- B. Progress bar
- C. Mute
- D. Volume
- E. Previous track
- F. Play / Pause
- G. Next track
- H. Play mode
- I. File folder
- J. Delete track from playlist
- K. Next page (playlist)
- L. Previous page (playlist)
- M. Playlist - Double click to play
- N. Close and exit

Press File folder to add files to playlist.



Note: Double tap the folder that you want to access.

### 5. Movie



- A. Return to Main menu
- B. Progress bar
- C. Mute
- D. Volume
- E. Previous video
- F. Play / Pause
- G. Next video
- H. Full screen
- I. File folder –double tap screen to
- J. Delete video from playlist
- K. Next page (playlist)
- L. Previous page (playlist)
- M. Playlist - Double click to play
- N. Close and exit

Press File folder to add files to playlist.



Note: Double tap the folder that you want to access.

## 6. Ebook

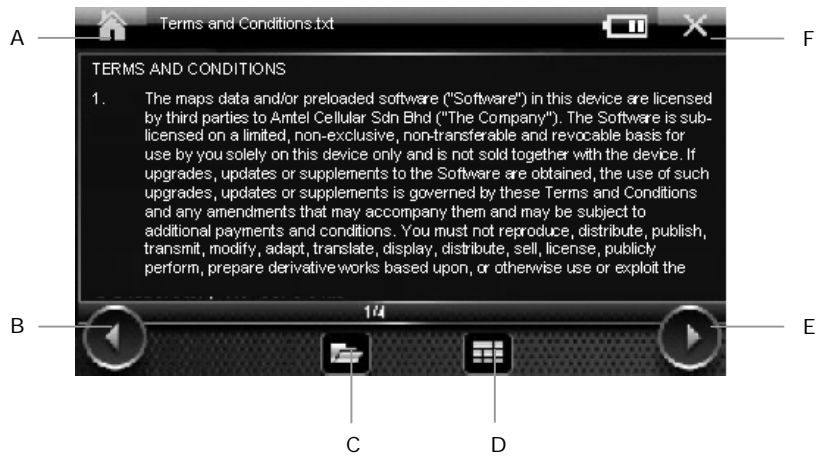

- A. Return to Main menu
- B. Previous page
- C. File folder
- D. Numeric keyboard to enter page no.
- E. Next page
- F. Close and exit

Press File folder to add files to playlist.



Note: Double tap the folder that you want to access.

## 8. GPS Info

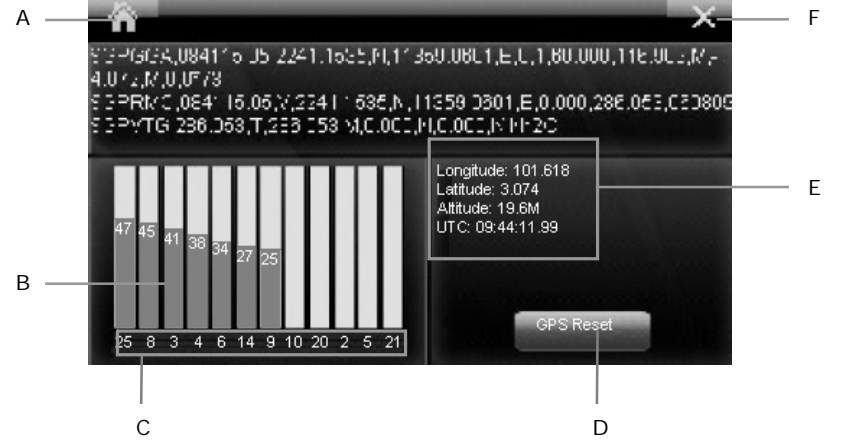

- A. Return to Main menu
- B. Satellite signal strength bar
- C. Satellite number
- D. To perform GPS cold start
- E. Coordinates information and time
- F. Close and exit

Note: The longitude, latitude, altitude and time will be obtained automatically once the navigator acquires sufficient satellite signals.

## Connecting your GPS navigator to computer

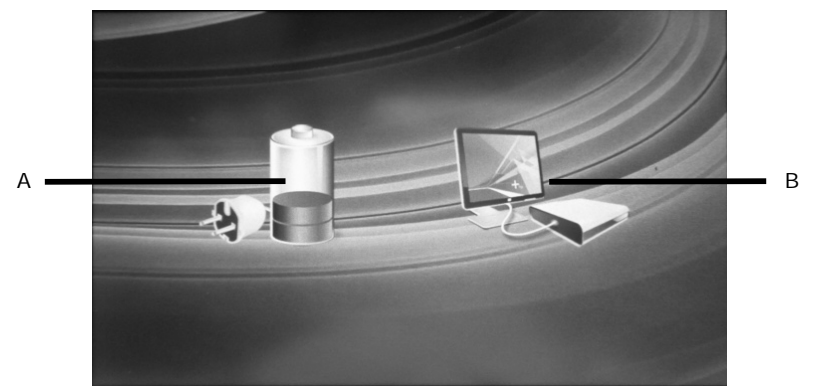

When the navigator is connected to computer using USB cable, the screen above will appear. Tap **A** to only charge the battery of the navigator and **B** to access to the navigator's storage (for file transfer).

## 7. Picture

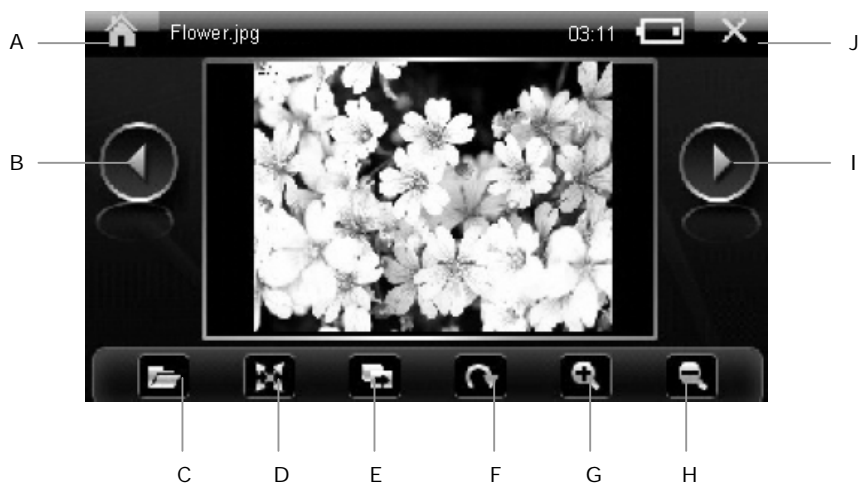

- A. Return to Main menu
- B. Previous picture
- C. File folder
- D. Full screen
- E. Slide show
- F. Rotate picture
- G. Zoom in
- H. Zoom out
- I. Next picture
- J. Close and exit

Press File folder to add files to playlist.



Note: Double tap the folder that you want to access.

## Specifications

Physical	Dimension	135.5 x 92 x 13.2mm
	Net Weight	187.7g
System	Operating system	Windows CE6.0
	CPU	SiRFAtlas IV, CPU 500MHz, ARM11; DSP 250MHz.
	DDR	128MB
	NAND Flash	4GB
	Storage	Support up to max 16GB Micro SD
Languages	2 Languages	English & Simplified Chinese
Multimedia	Movie	MP4, ASF, WMV, AVI and 3GP
	Music	MP3, WMA and WAV
	Picture	BMP, JPG and PNG
	Ebook	TXT
Power	Travel Adaptor	INPUT: AC 100-240V OUTPUT: DC 5V/2A
	In-Car Charger	INPUT: DC 12-24V OUTPUT: DC 5V/1.5A
	Battery	3.7V / 1600mAH
	Usage time	Approx. 2.5-3.5 hours
Display	Specification	5" TFT LCD, 4 line resistance flat touch screen
	Pixels	800 x 480, TFT with flat touch panel
	Brightness	Adjustable
Navigation Feature	GPS Frequency	1575.42MHz
	Channels	64
	Sensitivity	-161dBm
	Precision	Position: <10 meters
	Capture Time	Hot start: ≤3 sec, average Warm start: ≤38 sec, average Cold start: ≤45 sec, average
	Refreshing Rate	0.1/second
	Com port	COM7
	Baud Rate	38400
Temperature	Operation	-10 to 55°C
	Storage	Short-term: -25 to 75°C Long-term: -20 to 25°C
	Humidity	20% RH – 80%RH. Keep temperature below 40°C when humidity reaches 80% RH.
USB		USB 2.0 high speed
Bluetooth	Protocol Version	V2.0
	Function	Hands free for mobile phone
AVIN	Video Format	CLBS (PAL & NTSC)
	Input Impedance	75Ω
	Input Voltage	1.5Vpp
	Audio Format	Analog Signal

